



DES PDM 24



Cable entry plates with internal frame and double membrane

FEATURES

- For large number of cables without connectors
- High strain relief thanks to the double membrane
- Cost efficient solution
- IP66 and Nema 4X* certified
- ATEX version on request (see group 7)
- Threaded inserts version on request

The DES PDM 24 is an innovative alternative to standard cable glands on electrical, electronic and telecommunication cabinets and equipment. The cable is pushed through the front membrane, whilst the second membrane increases the strain relief and liquid resistance.

Material: TPE, halogens and silicones free

Flammability: self-extinguishing acc. to UL94-V0

Temperature: -40°C... +110°C (static)

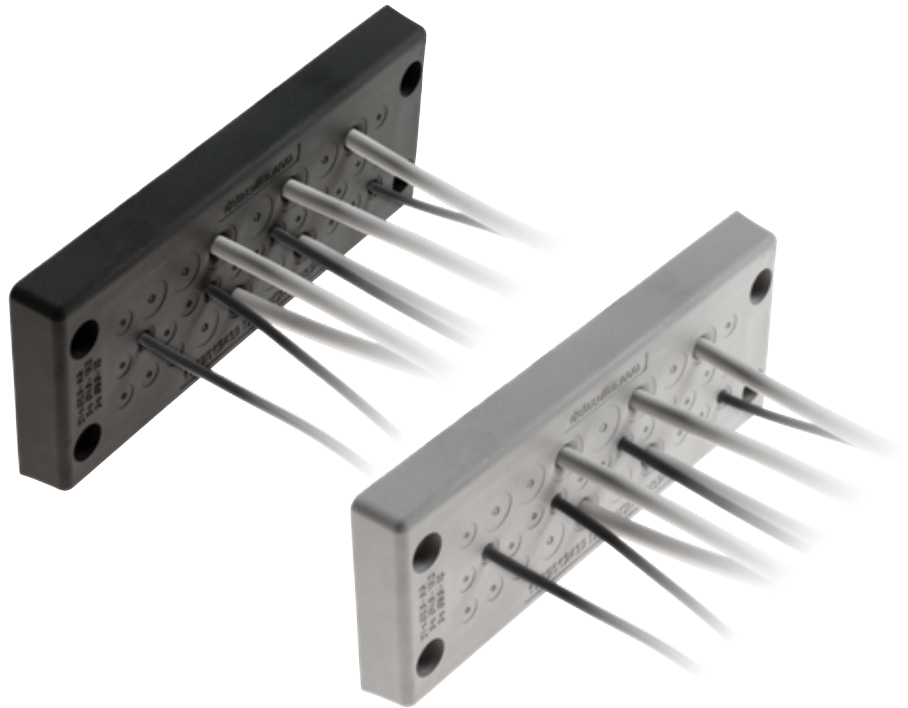

RELATED PRODUCTS

- IFP plugs (page 97)
- DES PDM caps (page 97)
- HY360 hydraulic punch driver (page 148)
- PF/PFX cable entry system plates (from page 150)

NC: Number of cables

ØC: Diameter of cables - min/max (mm)

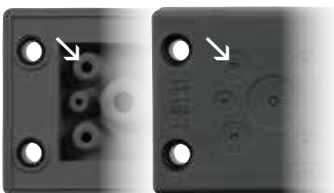
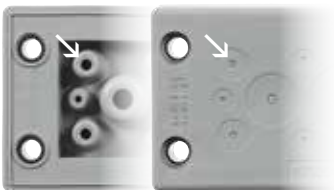

Double parallel membrane

* Indoor only

Model	Code
● DES PDM 24/3G	1732012403
● DES PDM 24/3B	1732013403
Cut-out / Plate (mm)	Pcs/pack
112 x 36 / 148,6 x 59,6	10
	NC 3
	ØC 18 / 26

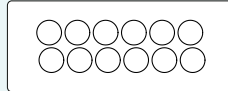
Model	Code
● DES PDM 24/12G	1732012412
● DES PDM 24/12B	1732013412
Cut-out / Plate (mm)	Pcs/pack
112 x 36 / 148,6 x 59,6	10
	NC 12
	ØC 9 / 16

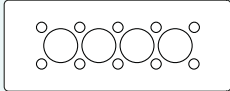
Model	Code
● DES PDM 24/14G	1732012414
● DES PDM 24/14B	1732013415
Cut-out / Plate (mm)	Pcs/pack
112 x 36 / 148,6 x 59,6	10
	NC 10
	ØC 2,8 / 6,5
	4 14,5 / 22

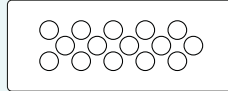
Model	Code
● DES PDM 24/15G	1732012415
● DES PDM 24/15B	1732013416
Cut-out / Plate (mm)	Pcs/pack
112 x 36 / 148,6 x 59,6	10
	NC 15
	ØC 6,8 / 12



IP66
IP68

NEMA
12, 4X*

UL TYPE
12, 4X



ECOLAB



RoHS
COMPLIANT





DES PDM 24



Cable entry plates with internal frame and double membrane

Model	Code
● DES PDM 24/16G	1732012416
● DES PDM 24/16B	1732013417

Cut-out / Plate (mm)	Pcs/pack
112 x 36 / 148,6 x 59,6	10

NC	ØC
8	2,8 / 6,5
4	4,4 / 9,7
2	8,6 / 16,2
2	14,5 / 22

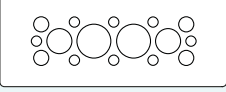

Model	Code
● DES PDM 24/17G	1732012417
● DES PDM 24/17B	1732013418

Cut-out / Plate (mm)	Pcs/pack
112 x 36 / 148,6 x 59,6	10

NC	ØC
6	2,8 / 6,5
6	4,6 / 10,2
5	8,6 / 16,2

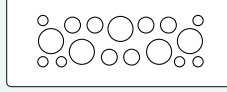

Model	Code
● DES PDM 24/25G	1732012425
● DES PDM 24/25B	1732013426

Cut-out / Plate (mm)	Pcs/pack
112 x 36 / 148,6 x 59,6	10

NC	ØC
12	2,8 / 6,5
7	4,4 / 9,7
6	6,8 / 12

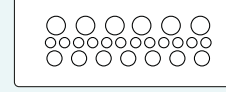

Model	Code
● DES PDM 24/26G	1732012426
● DES PDM 24/26B	1732013427

Cut-out / Plate (mm)	Pcs/pack
112 x 36 / 148,6 x 59,6	10

NC	ØC
26	4,6 / 10

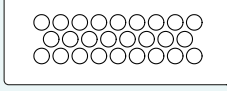

Model	Code
● DES PDM 24/32G	1732012432
● DES PDM 24/32B	1732013433

Cut-out / Plate (mm)	Pcs/pack
112 x 36 / 148,6 x 59,6	10

NC	ØC
21	2,8 / 6,5
8	4,6 / 10,2
3	6,8 / 12

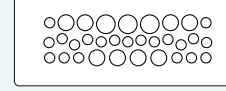

Model	Code
● DES PDM 24/42G	1732012442
● DES PDM 24/42B	1732013443

Cut-out / Plate (mm)	Pcs/pack
112 x 36 / 148,6 x 59,6	10

NC	ØC
42	2,8 / 6,5

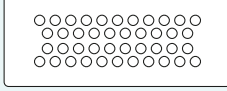

Model	Code
● DES PDM 24/124G	1732012421

Cut-out / Plate (mm)	Pcs/pack
112 x 36 / 148,6 x 59,6	10

NC	ØC
120	1,75 / 4,7
4	2,3 / 6

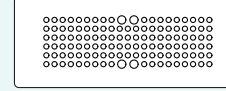

Dimensions (mm)

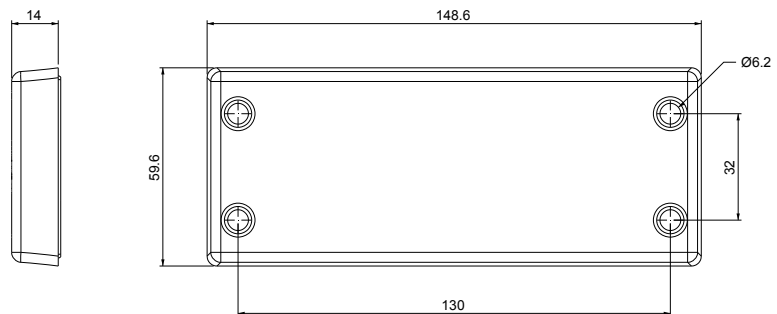

* Indoor only



IP66
IP68

NEMA
12, 4X*

UL TYPE
12, 4X



ECOLAB

